

Release date : 2011.07.04  
Model : QVL-GF08-V7 / Product code : GF08-1106-004

# GVIF Interface – v7 for Nissan & Infiniti Specification

# Contents

## 1. Before installation

1.1 Main specification	3
1.2 Features	4
1.3 System diagram	5
1.4 Components	6
1.5 Exterior	7

## 2. Setup

2.1 DIP switch	8
2.2 Remote controller	9
2.3 OSD Menu (On Screen Display)	10
2.4 FACTORY Mode (MENU for Installers)	11
2.5 Rear view parking guide line	12

## 3. Installation

3.1 Installation diagram	13
3.2 Cautions on installation	14
3.3 Example of installation in Nissan Patrol	15

## 4. Troubleshooting

16

## 5. GVIF (LVDS IN/OUT) cable problem

17

# 1.1 Main Specification

## 1. Input Spec. (MULTI VIDEO INTERFACE)

- 3 x **A/V Input** (for external video source – TV, DVB-T, DVD; **Auto detection NOT supported** )  
**Support only NTSC for Nissan and Infiniti**
- 1 x **REAR-C Input** (for external rear camera source; **Auto detection NOT supported**)  
**Support only NTSC for Nissan and Infiniti**
- 1 x **Analog RGBCs Input** (for navigation system)
- 1 x **GVIF Input** (LVDS input)

## 2. Output Spec.

- 1 x **GVIF Output** (LVDS output)
- 3 x **Audio Select** (12V power comes out from 3 wires by AV1, RGB & REAR modes – **MAXIMUM power available for each channel is 500 mA!!!**)

## 3. Power Spec.

- Input Power : 8VDC ~ 18VDC
- Consumption Power : 6WATT, Max

## 4. Switch Input mode

- Input Video DISABLE Function : Possible to make each input disable by operating Dip S/W.
- Possible to switch Input mode with Keypad
- Possible to switch Input mode with switch for source toggle

## 1.2 Features

- Improved High-definition
- Supports **only** NTSC
- Remote controller offered
- Possible to move the displayed position of AV, Navigation.
- Able to run OSD menu without image displayed.

# 1.3 System Diagram

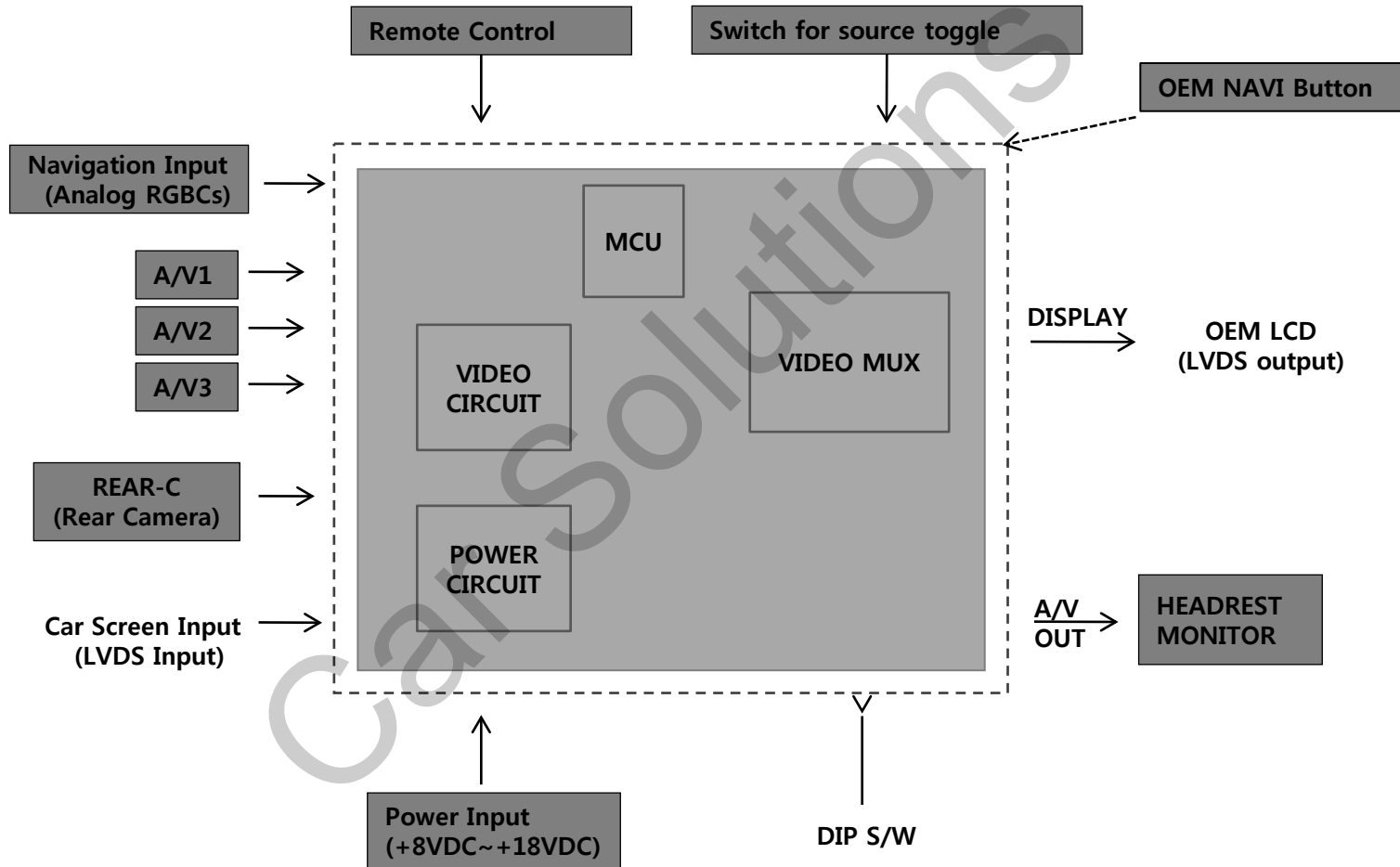

# 1.4 Components

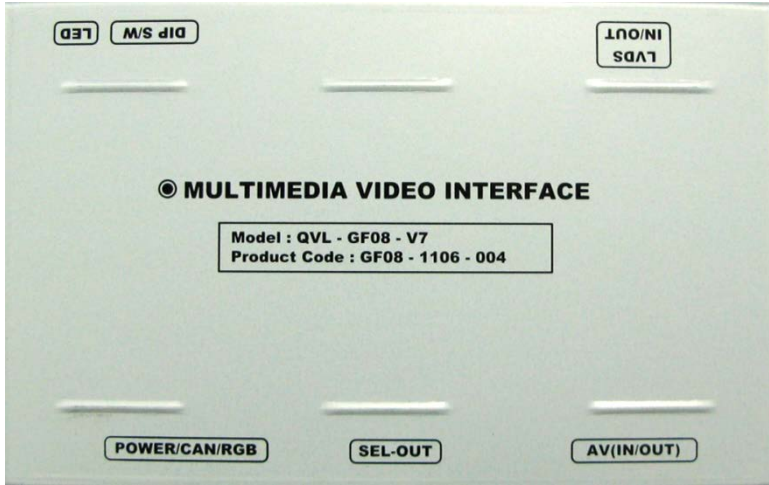

Main board \* 1pc.



MODE cable \* 1pc.

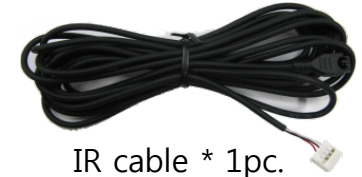

IR cable \* 1pc.

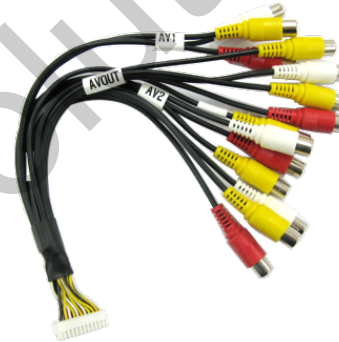

AV cable \* 1pc.



Nissan/Infiniti cable \* 1pc.

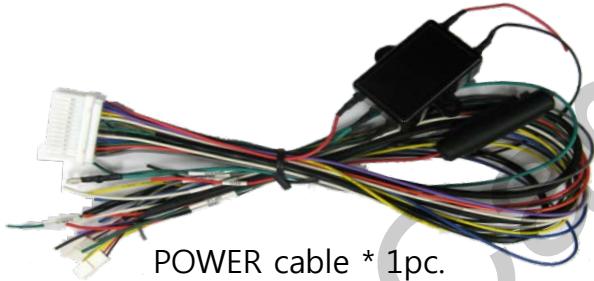

POWER cable \* 1pc.



SEL cable \* 1pc.



RGB cable \* 1pc.



Remote control \* 1pc.

# 1.5 Exterior



## Dimension

Horizontal length 139mm  
Vertical length 87mm  
Height 24mm

- ① POWER/CAN/RGB
- ② SEL-OUT
- ③ AV(IN/OUT)
- ④ LVDS IN/OUT
- ⑤ DIP S/W
- ⑥ LED

# 2.1 DIP switch

DIP #	Function	DIP S/W selection
1	RGB Input	ON : RGB Input is OFF OFF : RGB Input is ON
2	A/V1 Input	ON : AV1 Input is OFF OFF : AV1 Input is ON
3	A/V2 Input	ON : AV2 Input is OFF OFF : AV2 Input is ON
4	A/V3 Input	ON : AV3 Input is OFF OFF : AV3 Input is ON
5	Car Model	ON : NISSAN ₩ Infiniti cars OFF : <b>NOT USED</b>
6	OEM Video Input	ON : OEM input is OFF ( <i>OEM GVIF input</i> ) OFF : OEM input is ON ( <i>OEM GVIF input</i> )
7	Rear Mode	ON : External Rear Camera OFF : OEM Rear Camera
8		<b>NOT USED</b>

※ ON : DOWN, OFF : UP

## [NISSAN]

-Input mode to intend to use : MAIN + A/V3  
-Rear view camera : installation on REAR-C

- ▷ DIP S/W : 1,2,3 → ON (INPUT MODE SKIP)
- ▷ DIP S/W : 4 → OFF (A/V3 available)
- ▷ DIP S/W : 5 → ON
- ▷ DIP S/W : 6 → OFF
- ▷ DIP S/W : 7 → ON (REAR-C available)
- ▷ DIP S/W : 8 → OFF





## 2.2 Remote controller

Buttons	Function
POWER & PIP	<b>NOT USED</b>
MENU	OSD Menu
OK	Making a selection
▲	Move UP
▼	Move DOWN
◀	Move LEFT <i>(or press 2 sec. - Factory mode)</i>
▶	Move RIGHT <i>(or press 2 sec. - Factory Reset)</i>



# 2.3 OSD (On Screen Display)

**OSD menu: Press "MENU" button on the remote control.**

Analog RGB MODE

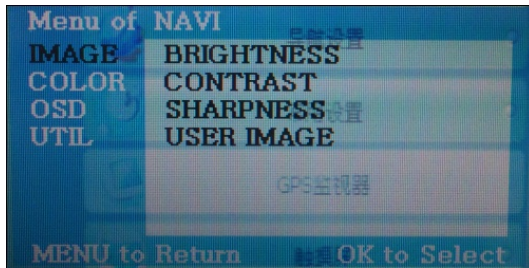

Analog RGB MODE

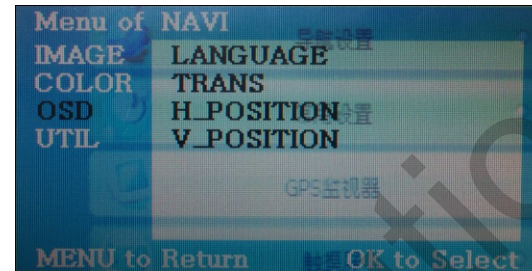

Analog RGB MODE



Video MODE



Video MODE

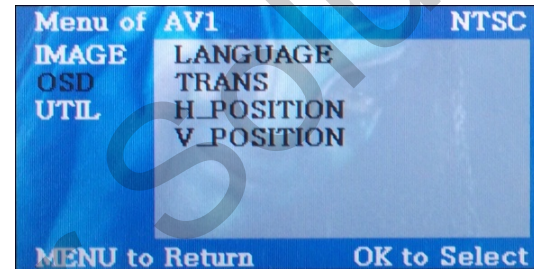

Video MODE



## IMAGE

- BRIGHTNESS
- CONTRAST
- SATURATION
- HUE
- SHARPNESS
- USER IMAGE : To choose a option among 4 prepared color shade.

## OSD

- LANGUAGE : To change the language displaying on navigation, DVD, CMMB OSD menu (select 1 among English or Chinese)
- TRANS : Transparency control of the OSD background
- H\_POSITION : Horizontal movement of the OSD window
- V\_POSITION : Vertical movement of the OSD window

## UTIL

- FACTORY RESET : To reset all the values about navigation, DVD screen to factory default. (NOT available for reset of the position value of images, only for functions inside OSD menu)

# 2.4 Factory mode

**Factory mode: Press ◀ button 2 seconds.**

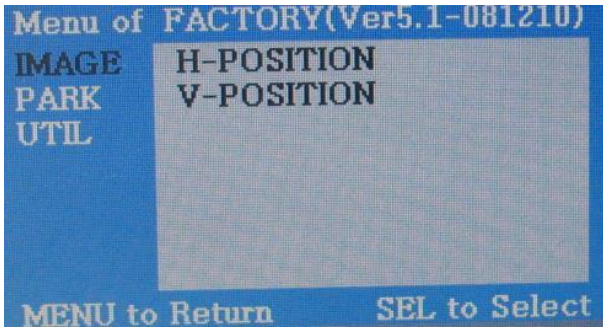

## IMAGE

- H\_POSITION : Horizontal movement of the OSD window
- V\_POSITION : Vertical movement of the OSD window



## PARK

- PARK ENABLE : Setup of rear view parking guide line
- PARK SETUP : Control over position of rear view parking guide line.  
(Refer to page 12)
- SAFE ENABLE : To select whether to use SAFE function (NOT to allow watch video while driving) or not.

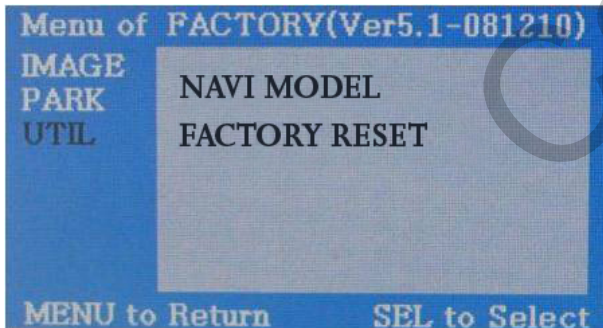

## UTIL

- NAVI MODEL : Default – for Navigation unit with resolution 480x234 (400x234)  
NAV N GO – for Navigation unit with resolution 480x234 (400x234)  
KD680\_NEW – for Navigation unit with resolution 800x480
- FACTORY RESET : To reset all the value in factory mode

# 2.5 Rear view parking guide line

**Factory mode: Press ◀ button 2 seconds.**

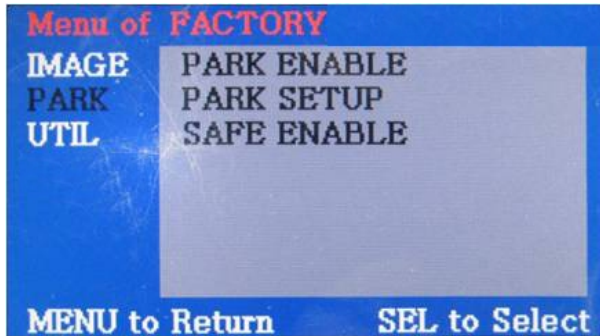

① Register the value needed on the "PARK ENABLE" as "ON" in the PARK section as shown left. **(default is ON)**

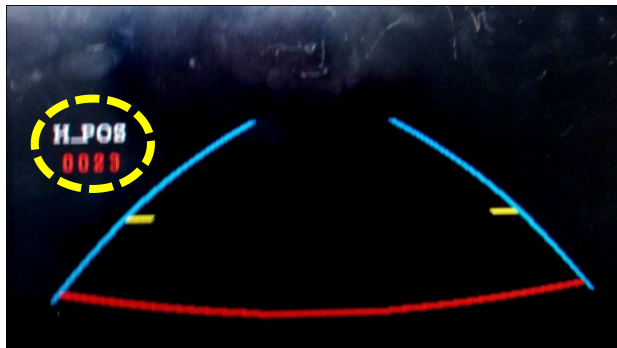

② If you get rear gear after setup, parking guide line will appear on screen as shown left. Now that you push "OK" button, you can see "H-POS" on the left of screen. Then adjust horizontal position of the guide line.

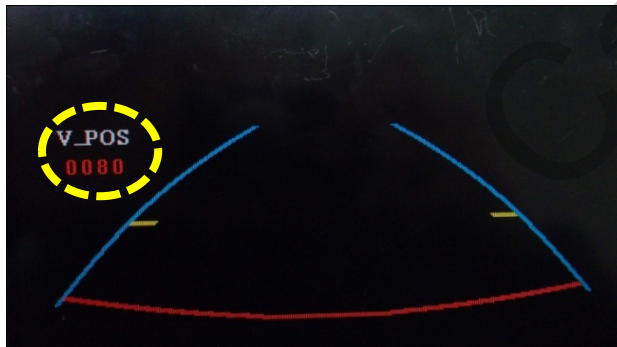

③ After adjusting horizontal position, press "OK" on the remote controller. Then you can see "V-POS" on the left of screen. At that time you can adjust vertical position of the guide line.

# 3.1 Installation diagram

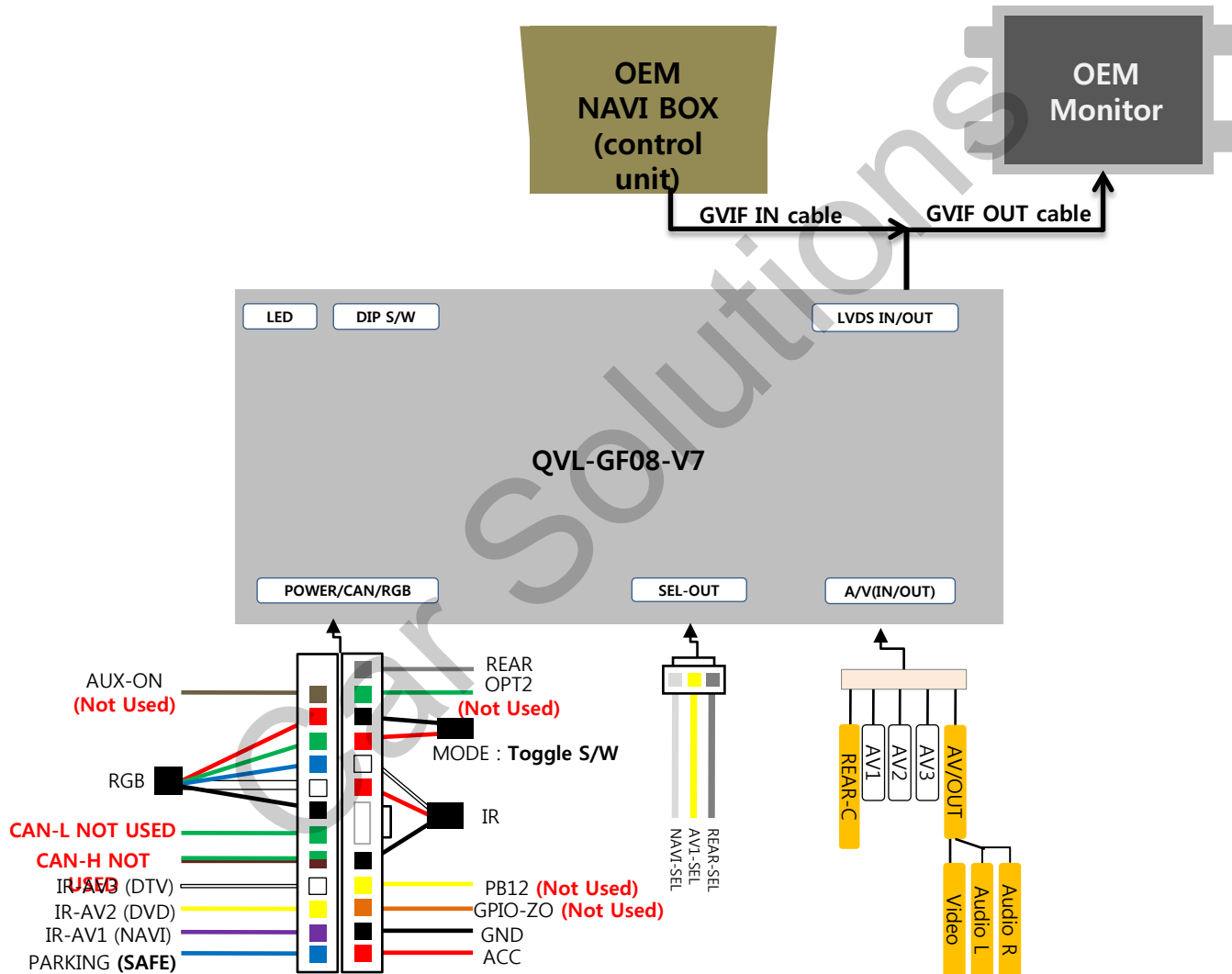



## 3.2 Cautions on installation

- Ignition key should be taken off before starting installation, interface power connection must be the last step in installation.
- Power cable should be separated when connecting interface.
- Should be no any electronic devices or magnetic pole around installation place.
- All steps of installation should be done by well-trained specialist.
- Dismantling without manufacturer's permission can not be guaranteed, (No permission to break attached label on the board.)
- Kindly check all parts are in the box, when receiving the product, if anything missing, inform to the supplier or manufacturer.
- According to our sales policy, any problems caused by user's mistake, careless can not be guaranteed.

# 3.3 Example of installation in Nissan Patrol

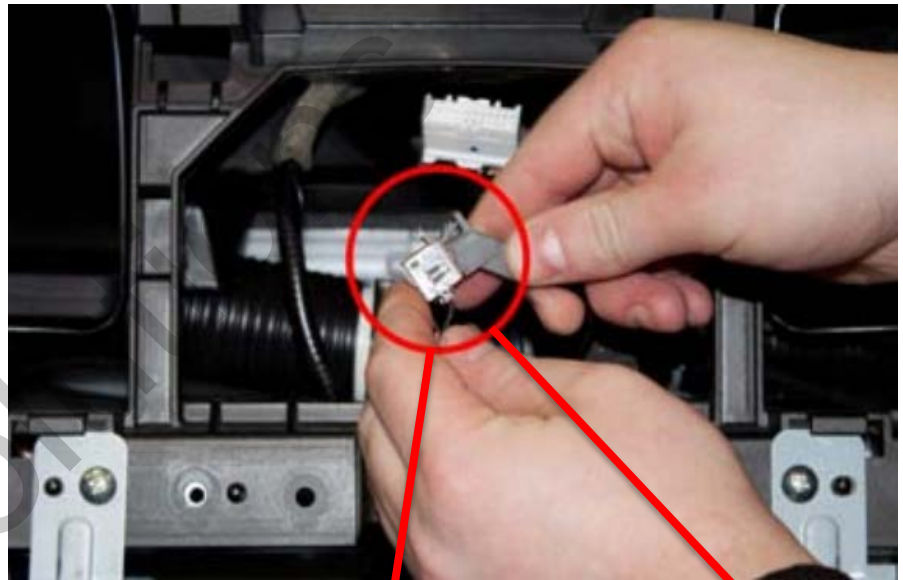
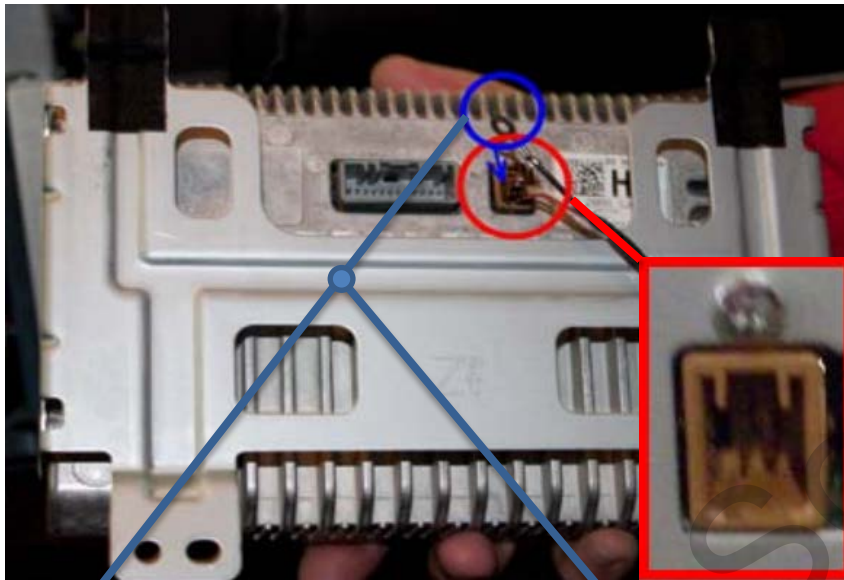

**WARNING!**

Connect ring terminal to display framework in order to remove signal potential difference between video interface and OEM car display



# 4. Troubleshooting

**Q. I can not switch A/V sources.**

A. Check IR or Ground cable connection. Check LED lamps in the interface, if it is not on, check power cable.

**Q. All I got on the screen is black.**

A. Check second LED lamp of the interface is on, if not, check A/V sources connected are working well.  
(Second lamp indicates AV sources connected works well.) Check interface connection has been done well.

**Q. Displayed image color is not proper.**

A. Try to select "INITIAL" in OSD menu if it does not work, inform the manufacturer.

**Q. Rear camera image does NOT appear.**

A. Set DIP switch #7 in "ON"

**Q. Unwanted A/V mode is displayed. (A/V source switching order : OEM->RGB->AV1->AV2->AV3)**

A. Check DIP Switch Setting.

**Q. OEM image is not displayed.**

**A. Check interface's LVDS In/Out cable connection. Swap RED and WHITE wires in LVDS IN/OUT cable**

If the status keeps on, inform the manufacturer.

**Q. Screen only displays white like left picture.**

A. Check LCD out cable is connected well, if this status keeps, inform the manufacturer.



# 5. GVIF (LVDS IN/OUT) cable problem

**PROBLEM:** GVIF output doesn't work



**SOLUTION:** Swap the WHITE and RED wires in LVDS IN/OUT cable

